

COMBINATION FAN SWITCH

Specification	
Color	White
Electrical Input	120 volts @ 60Hz
Maximum Load	15 Amps
Connections	#14 or #12 copper wire

www.dewstop.com

INCLUDED WALL PLATE
▶ Switch fits all decora/GFCI/rocker single and multi-position wall plates

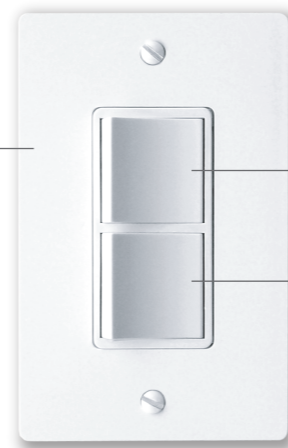

FUNCTION #1
▶ Manual Control

FUNCTION #2
▶ Manual Control

FSR-500-W4 - White - Qty: 1



Made in PRC  Go To Research Technologies, Inc. Seattle, WA, USA

www.dewstop.com

Specification	
Color	White
Electrical Input	120 volts @ 60Hz
Maximum Load	15 Amps
Connections	#14 or #12 copper wire

COMBINATION FAN SWITCH

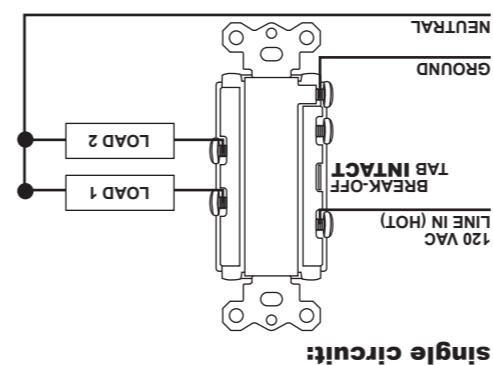
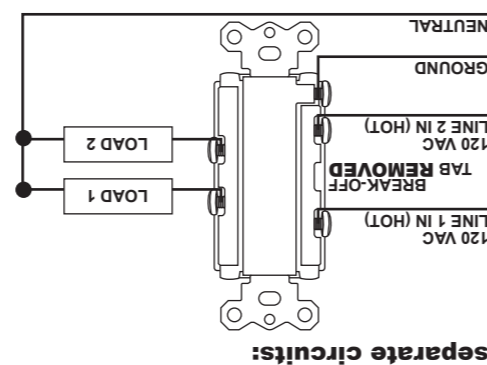

FSR-500-W



COMBINATION FAN SWITCH

2 Independent Functions

2 Rocker Switch

Works with ANY ventilation fan

Compatible with ALL makers of:
Fans, Lights, Heaters

from **DewStop** 2-Function

FSR-500-W



COMBINATION FAN SWITCH







2 Independent Functions

2 Rocker Switch

Works with ANY ventilation fan

Compatible with ALL makers of:
Fans, Lights, Heaters

COLORS:

-  (c)0 (m)0 (y)0 (k)62
62% Black
-  (c)0 (m)28 (y)75 (k)17
75% Pantone 139 C
-  (c)0 (m)27 (y)100 (k)54
Pantone 140 C
-  (c)0 (m)0 (y)0 (k)100
Black
-  (c)0 (m)0 (y)0 (k)0
White
-  Box Layout (don't print)

Description: FSR-500-W4 1-pack box
Revision Date: 5-1-2014

THIS ARTWORK IS THE PROPERTY OF GTR TECHNOLOGIES, INC. AND TRANSMITTED IN CONFIDENCE. THE REPRODUCTION, USE, OR DISCLOSURE, IN WHOLE OR IN PART, OF THE DESIGN AND DETAILS CONTAINED HEREIN IS PROHIBITED WITHOUT THE WRITTEN PERMISSION OF GTR TECHNOLOGIES, INC.

Made Using Adobe Illustrator CS v11.0.0